

Article number: 12706000035120

Description: KLEE-coil 706 000 035.120

M3,5 Unhardened, zinc-pl. & chr. yellow

Measures

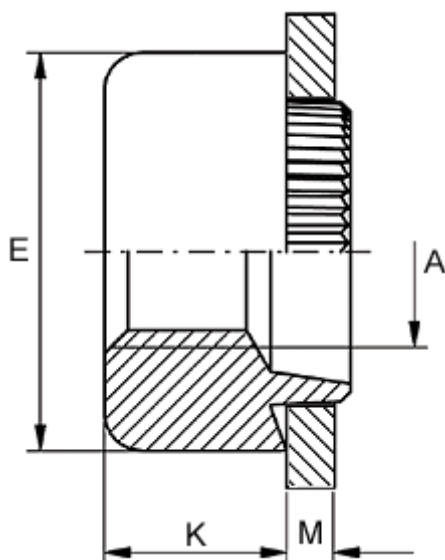

Female thread A	= M3,5
Height K	= 4.0
Outer diameter E	= 10.0
Plate thickness	= 1.4 to 1.6
Recommended bore diameter for extreme load	= 7.0
Recommended bore diameter for normal use	= 7.0